

BLi-40/100

Art. 9842

BLi-40/160

Art. 9843



DE Betriebsanleitung System-Accu	SK Návod na obsluhu Systémový akumulátor
EN Operator's Manual System battery	EL Οδηγίες χρήσης Μπαταρία συστήματος
FR Mode d'emploi Batterie du système	RU Инструкция по эксплуатации Акумуляторная батарея System
NL Gebruiksaanwijzing Systeemaccu	SL Navodilo za uporabo Sistemska baterija
SV Bruksanvisning Systembatteri	HR Uputa za upotrebu Baterija
DA Brugsanvisning Systembatteri	SR/BS Uputstvo za korisnike Sistemska baterija
FI Käyttöohje Järjestelmäakku	UK Інструкція з експлуатації Система акумуляторної батареї
NO Bruksanvisning Systembatteri	RO Instrucțiuni de utilizare Bateria
IT Istruzioni per l'uso Batteria	TR Kullanma Kılavuzu Sistem aküsü
ES Instrucciones de empleo Batería del sistema	BG Инструкция за експлоатация Батерия за системата
PT Manual de instruções Bateria do sistema	SQ Manual përdorimi Bateri sistemi
PL Instrukcja obsługi Akumulator systemowy	ET Kasutusjuhend Akusüsteem
HU Használati utasítás Rendszerakkumulátor	LT Naudojimosi instrukcija Sistemos akumulatorius
CS Návod k obsluze Systémová baterie	LV Lietošanas instrukcija Sistēmas akumulators

BLi-40/100 / 2,6 Ah (Art. 9842)

BLi-40/160 / 4,2 Ah (Art. 9843)

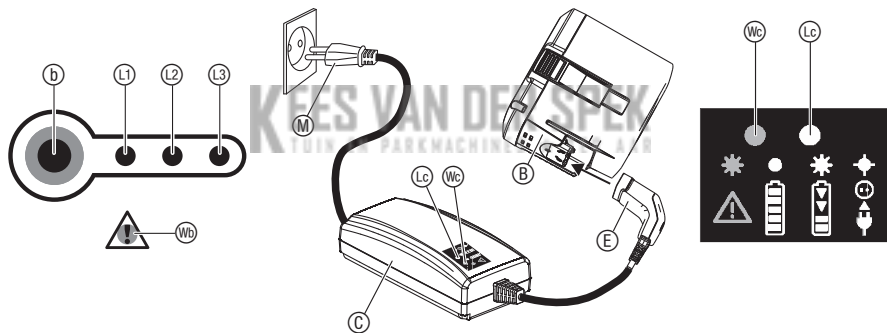

GARDENA System Battery**BLI-40/100 Art. 9842****BLI-40/160 Art. 9843****Original instructions.**

Please read these operating instructions carefully and read the notes given. Acquaint yourself with the use of the battery, the charging technology (see operating instructions GARDENA Rechargeable Battery unit) and read the safety instructions.

For safety reasons, children under the age of 16 as well as people, who are not acquainted with the instructions should not use the battery. Persons with reduced physical or mental abilities may use the product only if they are supervised or instructed by a responsible person. Children must be supervised to ensure that they do not play with the product. Never operate the product when you are tired, ill or under the influence of alcohol, drugs or medicine.

Intended use:

The **GARDENA System Battery** is used as a power supply for the relevant GARDENA cordless products and is intended for use in private house and hobby gardens. The battery must not be used in public facilities, parks, sports grounds, next to roads or in agriculture or forestry.

1. SAFETY**Important!**

Read the operator's manual carefully before use and keep for future reference.

Symbols on the product:

→ Observe the safety instructions on the battery.



→ **Do not expose the battery to rain or wet conditions.**

Water entering a battery will increase the risk of electric shock.

General safety warnings:**Electrical safety:**

DANGER! Fire risk!

→ **The battery to be charged must be placed on a non-flammable, heat resistant and non-conductive surface while charging.**

Keep corrosive, flammable and easily combustible objects clear of the battery charger and the battery.

Do not cover the battery charger and the battery while charging.

Disconnect the battery charger immediately in the event of smoke formation or fire.

Only use the original GARDENA Charger to charge the battery. The use of other battery chargers may damage the batteries irreparably and even cause a fire.

If you notice fire: Extinguish the flames with oxygen reducing materials.

Do not bridge the contacts of the battery with metal components.



DANGER! Risk of explosion!

Protect batteries from heat and fire. Do not leave on radiators or expose to strong sunshine for long periods.

Do not operate in explosive atmospheres, such as in the presence of flammable liquids, gases, or dust.

Batteries may create sparks which could ignite the dust or fumes.

Check your battery before each use:

Visually check the battery before each use. A non-functioning battery must be disposed of correctly. **For Art. 9843:** Do not send by post. For further details, please contact your local disposal companies.

For risks of injury do not use the battery as a power source for other products. Only use the battery for the GARDENA product intended.

Only charge the battery in ambient temperatures of between 0 °C and 40 °C. Allow battery to cool down after long periods of use.

Check the charging cable regularly for signs of damage or ageing (brittleness). Only use it in perfect condition.

Do not store the battery above 45 °C or in direct sunlight. Ideally, the battery should be stored below 25 °C so that self-discharge is low.

Keep battery in order (clean) especially air vents.

If usage of the battery is not planned for a certain time (winter period) reload the battery to avoid a deep discharge.

Do not store while still attached to a tool, this prevents misuse and accidents.

Do not store the battery in places where static electricity is present.

Additional safety warnings:

DANGER! This product makes an electromagnetic field while it operates. This field may under some conditions interfere with active or passive medical implants. To decrease the risk of conditions that can possibly injure or kill, we recommend persons with medical implants to speak with their physician and the medical implant manufacturer before you operate the product.

DANGER! Small parts can be easily swallowed. There is also a risk that the polybag can suffocate toddlers. Keep toddlers away when you assemble the product.

2. INITIAL OPERATION

To charge the battery (see page 3):







ATTENTION!

Overvoltage damages the battery and the battery charger.

→ Make sure that you use the correct mains voltage.





Before you use the battery the first time, the battery must be completely charged.

The lithium-ion battery can be charged in any state of charge and the charging process can be disconnected at any time without to damage the battery (no memory effect).









1. Connect the mains cable  to the battery charger .
2. Connect the mains cable  to a mains socket.
3. Connect the battery charger cable  to the battery .

When the charging control lamp  at the charger flashes green once per second the battery is being charged.

When the charging control lamp  at the charger illuminates green the battery is completely charged (For charging time, see 6. TECHNICAL DATA).

4. Examine the charge status regularly while you charge.
5. When the battery  is completely charged, disconnect the battery  from the battery charger .
6. Disconnect the battery charger  from the mains.

Battery charging indicator during charging:

100 % charged	 ,  and  illuminate
66 – 99 % charged	 and  illuminate,  flashes
33 – 65 % charged	 illuminates,  flashes
0 – 32 % charged	 flashes

Battery charging indicator during operation:

→ Push the button  on the battery.

66 – 99 % charged ,  and  illuminate

33 – 65 % charged  and  illuminate

10 – 32 % charged  illuminates

0 – 10 % charged  flashes

3. MAINTENANCE

Make sure that the surface and the contacts of the battery and the battery charger always are clean and dry before you connect the battery charger.

Do not use running water.

→ Clean the contacts with a soft and dry cloth.

4. STORAGE

To put into storage:

The product must be stored away from children.

1. Charge the battery.
2. Store the battery in a dry, moisture-free and frost-free place.

Disposal of the battery:



The GARDENA battery contains lithium-ion cells that should not be disposed of with normal household waste at the end of its life.

Important!





Dispose of the batteries through or via your municipal recycling collection centre.

1. Discharge the lithium-ion cells completely (contact the GARDENA Service).
2. Protect the contacts on the lithium-ion cells against short circuits.
3. Dispose of the lithium-ion cells properly.

5. TROUBLESHOOTING

Error messages of the error-LED / (see page 3).

Problem	Possible Cause	Remedy
Error-LED  on the battery flashes	Under voltage. Battery temperature is out of range.	→ Charge the battery. → Use the battery in surroundings where temperatures are between –10 °C and 40 °C.

Problem	Possible Cause	Remedy
Error-LED  on the battery illuminates	Battery error/battery defective.	→ Contact the GARDENA Service.
Charging control lamp  on the charger does not illuminate	Battery charger or charging cable are not connected correctly.	→ Connect the battery charger and charging cable correctly.
Charging control lamp  on the charger flashes rapidly (4 times per second)	Battery temperature is out of range.	→ Use the battery in surroundings where temperatures are between –10 °C and 40 °C.
Error-LED  on the charger flashes	Battery error.	→ Remove the battery and check that you use an original GARDENA battery.
Error-LED  on the charger illuminates	Temperature inside the charger is too high.	→ Contact the GARDENA service.

NOTE: For any other malfunctions please contact the GARDENA service department. Repairs must only be done by GARDENA service departments or specialist dealers approved by GARDENA.

6. TECHNICAL DATA

System Battery BLI-40	Unit	Value (Art. 9842)	Value (Art. 9843)
Max. Battery voltage	V (AC)	40*	40*
Battery capacity	Ah	2.6	4.2
Battery charging time 80 % / 100 % (approx.)	min.	65/90	105/140

* The maximum initial no-load voltage of the battery is 40 V, the nominal voltage is 36 V.

7. SERVICE / WARRANTY

Service:

Please contact the address on the back page.

Warranty:

In the event of a warranty claim, no charge is levied to you for the services provided. GARDENA Manufacturing GmbH offers a two-year warranty (effective as of the date of purchase) for this product. This warranty includes all significant defects of the product that can be proved to be material or manufacturing faults.

For Art. 9842: This warranty is fulfilled by supplying a fully functional replacement product or by repairing the faulty product sent to us free of charge; we reserve the right to choose between these options. This service is subject to the following provisions:

For Art. 9843: The warranty will be fulfilled by the supply of a working replacement product provided that the following conditions are met:

- The product was used for its intended purpose as per the recommendations in the operating instructions.
- Neither the purchaser nor a third party has attempted to repair the product.

This manufacturer's warranty does not affect warranty entitlements against the dealer/retailer.

For Art. 9842: If problems arise with this product, please contact our Service department or send the defective product along with a brief description of the fault to GARDENA Manufacturing GmbH, making sure to have sufficiently covered any shipping costs and to have followed the relevant postage and packaging guidelines. A warranty claim must be accompanied by a copy of the proof of purchase.

For Art. 9843: For troubleshooting, please contact our Service department (contact details see back page). It is not permitted to send a product to us without prior agreement.

Product Liability:

In accordance with the German Product Liability Act, we hereby expressly declare that we accept no liability for damage incurred from our products where said products have not been properly repaired by a GARDENA-approved service partner or where original GARDENA parts or parts authorised by GARDENA were not used.

KEES VAN DER SPEK
TUIN EN PARKMACHINES ★ TER AAR

<p>FR Responsabilité Conformément à la loi relative à la responsabilité du fait des produits défectueux, nous déclarons expressément par la présente que nous déclinons toute responsabilité pour les dommages résultant de nos produits, si lesdits produits n'ont pas été correctement réparés par un partenaire d'entretien agréé GARDENA ou si des pièces d'origine GARDENA ou des pièces agréées GARDENA n'ont pas été utilisées.</p>	<p>IT Responsabilità del prodotto In conformità con la Legge tedesca sulla responsabilità del prodotto, con la presente dichiariamo espressamente che decliniamo qualsiasi responsabilità per danni causati dai nostri prodotti qualora non siano stati correttamente riparati presso un partner di assistenza approvato GARDENA o laddove non siano stati utilizzati ricambi originali o autorizzati GARDENA.</p>
<p>NL Productaansprakelijkheid Conform de Duitse wet inzake productaansprakelijkheid verklaren wij hierbij uitdrukkelijk dat wij geen aansprakelijkheid aanvaarden voor schade ontstaan uit onze producten waarbij deze producten niet zijn gerepareerd door een GARDE-NA-erkende servicepartner of waarbij geen originele GARDENA-onderdelen of onderdelen die door GARDENA zijn goedgekeurd zijn gebruikt.</p>	<p>ES Responsabilidad sobre el producto De acuerdo con la Ley de responsabilidad sobre productos alemana, por la presente declaramos expresamente que no aceptamos ningún tipo de responsabilidad por los daños ocasionados por nuestros productos si dichos productos no han sido reparados por un socio de mantenimiento aprobado por GARDENA o si no se han utilizado piezas originales GARDENA o piezas autorizadas por GARDENA.</p>
<p>SV Produktansvar I enlighet med tyska produktansvarslagar förklarar vi härmed uttryckligen att vi inte åtar oss något ansvar för skador som orsakas av våra produkter där produkterna inte har genomgått korrekt reparation från en GARDENA-godkänd servicepartner eller där originaldelar från GARDENA eller delar godkända av GARDENA inte använts.</p>	<p>PT Responsabilidade pelo produto De acordo com a lei alemã de responsabilidade pelo produto, declaramos que não nos responsabilizamos por danos causados pelos nossos produtos, caso os tais produtos não tenham sido devidamente reparados por um parceiro de assistência GARDENA aprovado ou se não tiverem sido utilizadas peças GARDENA originais ou peças autorizadas pela GARDENA.</p>
<p>DA Produktansvar I overensstemmelse med den tyske produktansvarslav erklærer vi hermed udtrykkeligt, at vi ikke påtager os noget ansvar for skader på vores produkter, hvis de pågældende produkter ikke er blevet repareret korrekt af en GARDENA-godkendt servicepartner, eller hvor der ikke er brugt originale GARDENA-reservedele eller godkendte reservedele fra GARDENA.</p>	<p>PL Odpowiedzialność za produkt Zgodnie z niemiecką ustawą o odpowiedzialności za produkt, niniejszym wyrażnie oświadczamy, że nie ponosimy żadnej odpowiedzialności za szkody poniesione na skutek użytkowania naszych produktów, w przypadku gdy naprawa tych produktów nie była odpowiednio przeprowadzana przez zatwierdzonego przez firmę GARDENA partnera serwisowego lub nie stosowano oryginalnych części GARDENA albo części autoryzowanych przez tę firmę.</p>
<p>FI Tuotevastuu Saksan tuotevastuulain mukaisesti emme ole vastuussa laitteiden vaurioista, jos korjauksia ei ole tehnyt GARDENAn hyväksymä huoltoliike tai jos niiden syynä on muiden kuin alkuperäisten GARDENA-varaosien tai GARDENAn hyväksymien varaosien käyttö.</p>	<p>HU Termékszavatosság A németországi termékszavatossági törvénnyel összhangban ezennel nyomatékosan kijelentjük, hogy nem vállalunk felelősséget a termékeinkben keletkezett olyan károkért, amelyek valamely GARDENA által jóváhagyott szervizpartner által nem megfelelően végzett javításból adódtak, vagy amely során nem eredeti GARDENA alkatrészeket vagy a GARDENA által jóváhagyott alkatrészeket használtak fel.</p>

<p>CS Odpovědnost za výrobek V souladu s německým zákonem o odpovědnosti za výrobek tímto výslovně prohlašujeme, že nepřijímáme žádnou odpovědnost za poškození vzniklá na našich výrobcích, kdy zmíněné výrobky nebyly řádně opraveny schváleným servisním partnerem GARDENA nebo kdy nebyly použity originální náhradní díly GARDENA nebo náhradní díly autorizované společností GARDENA.</p>	<p>RO Răspunderea pentru produs În conformitate cu Legea germană privind răspunderea pentru produs, declarăm în mod expres prin prezentul document că nu acceptăm nicio răspundere pentru defecțiunile suferite de produsele noastre atunci când acestea nu au fost reparate în mod corect de un atelier de service partener, aprobat de GARDENA, sau când nu au fost utilizate piese GARDENA originale sau piese autorizate de GARDENA.</p>
<p>SK Zodpovednosť za produkt V súlade s nemeckými právnymi predpismi upravujúcimi zodpovednosť za výrobok týmto výslovne prehlasujeme, že nenesieme žiadnu zodpovednosť za škody spôsobené našimi výrobkami, v prípade ktorých neboli náležité opravy vykonané servisným partnerom schváleným spoločnosťou GARDENA alebo neboli použité diely spoločnosti GARDENA alebo diely schválené spoločnosťou GARDENA.</p>	<p>BG Отговорност за вреди, причинени от стоки Съгласно германския Закон за отговорността за вреди, причинени от стоки, с настоящото изрично декларираме, че не носим отговорност за щети, причинени от нашите продукти, ако те не са били правилно ремонтирани от одобрен от GARDENA сервиз или ако не са използвани оригинални части на GARDENA или части, одобрени от GARDENA.</p>
<p>EL Ευθύνη προϊόντος Σύμφωνα με τον γερμανικό νόμο περί Ευθύνης για τα Προϊόντα, με το παρόν δηλώνουμε ρητώς ότι δεν αποδεχόμαστε καμία ευθύνη για τυχόν ζημιές που προκύπτουν από τα προϊόντα μας εάν αυτά δεν έχουν επισκευαστεί σωστά από κάποιον εγκεκριμένο συνεργάτη επισκευών της GARDENA ή εάν δεν έχουν χρησιμοποιηθεί αυθεντικά εξαρτήματα GARDENA ή εξαρτήματα εγκεκριμένα από την GARDENA.</p>	<p>ET Tootevastutus Vastavalt Saksamaa tootevastutusseadusele deklareerime käesolevaga selgesõnaliselt, et me ei kannu mingisugust vastutust meie toodetest tingitud kahjude eest, kui need tooted ei ole korrektselt parandatud GARDENA heakskiidetud hoolduspartneri poolt või kui parandamisel ei ole kasutatud GARDENA originaalosi või GARDENA volitatud osi.</p>
<p>SL Odgovornost proizvajalca V skladu z nemškimi zakoni o odgovornosti za izdelke, izrecno izjavljajo, da ne sprejemamo nobene odgovornosti za škodo, ki jo povzročijo naši izdelki, če teh niso ustrezno popravili GARDENINI odobreni servisni partnerji ali pri tem niso bili uporabljeni originalni GARDENINI nadomestni deli ali GARDENINIMI homologiranimi nadomestnimi deli.</p>	<p>LT Gaminio patikimumas Mes aiškiame pareiškiame, kad, atsižvelgiant į Vokietijos gaminių patikimumo įstatymą, neprisiimame atsakomybės dėl bet kokios žalos, patirtos dėl mūsų gaminių, jeigu jie buvo netinkamai taisomi arba jų dalys buvo pakeistos neoriginaliomis GARDENA dalimis ar nepatvirtintomis dalimis, arba jeigu remonto darbai buvo atliekami ne GARDENA techninės priežiūros centro specialistų.</p>
<p>HR Pouzdanost proizvoda Sukladno njemačkom zakonu o pouzdanosti proizvoda, ovime izričito izjavljujemo kako ne prihvaćamo nikakvu odgovornost za oštećenja na našim proizvodima nastala uslijed neispravnog popravka od strane servisnog partnera kojeg odobrava GARDENA ili uslijed nekorištenja originalnih GARDENA dijelova ili dijelova koje odobrava GARDENA.</p>	<p>LV Atbildība par produkcijas kvalitāti Saskaņā ar Vācijas likumu par atbildību par produkcijas kvalitāti ar šo mēs paziņojam, ka neuzņemamies atbildību par bojājumiem, kas radušies, lietojot mūsu izstrādājumus, kuru remontu nav veicis uzņēmuma GARDENA apstiprināts apkopes partneris vai kuru remontam netika izmantotas oriģinālās GARDENA detaļas vai detaļas, kuru lietošanu apstiprinājis uzņēmums GARDENA.</p>

<p>DE EU-Konformitätserklärung</p> <p>Der Unterzeichner, Husqvarna AB, 561 82 Huskvarna, Schweden, bescheinigt hiermit, dass die nachstehend aufgeführten Geräte bei Verlassen des Werks die harmonisierten EU-Leitlinien, EU-Normen für Sicherheit und besondere Normen erfüllen. Dieses Zertifikat verliert seine Gültigkeit, wenn die Geräte ohne unsere Genehmigung verändert werden.</p>	<p>IT Dichiarazione di conformità CE</p> <p>La sottoscritta Husqvarna AB, 561 82 Huskvarna, Svezia, certifica che il prodotto qui di seguito indicato, nei modelli da noi commercializzati, è conforme alle direttive armonizzate UE nonché agli standard di sicurezza UE e agli standard specifici di prodotto. Qualunque modifica apportata al prodotto senza nostra specifica autorizzazione invalida la presente dichiarazione.</p>
<p>EN EC Declaration of Conformity</p> <p>The undersigned, Husqvarna AB, 561 82 Huskvarna, Sweden, hereby certifies that, when leaving our factory, the units indicated below are in accordance with the harmonised EU guidelines, EU standards of safety and product specific standards. This certificate becomes void if the units are modified without our approval.</p>	<p>ES Declaración de conformidad CE</p> <p>El abajo firmante, Husqvarna AB, 561 82 Huskvarna, Suecia, certifica por la presente que, cuando salen de la fábrica, las unidades indicadas a continuación cumplen las normas de armonización de la UE, las normas de la UE sobre seguridad y las normas específicas del producto. Este certificado quedará sin efecto si se modifican las unidades sin nuestra autorización.</p>
<p>FR Déclaration de conformité CE</p> <p>Le constructeur, soussigné : Husqvarna AB, 561 82 Huskvarna, Suède, déclare qu'à la sortie de ses usines le matériel neuf désigné ci-dessous était conforme aux prescriptions des directives européennes énoncées ciaprès et conforme aux règles de sécurité et autres règles qui lui sont applicables dans le cadre de l'Union européenne. Toute modification apportée à cet appareil sans notre accord annule la validité de ce certificat.</p>	<p>PT Declaração de conformidade CE</p> <p>O abaixo-assinado, Husqvarna AB, 561 82 Huskvarna, Suécia, certifica por este meio que, ao sair da nossa fábrica, as unidades indicadas acima estão em conformidade com as diretivas uniformizadas da UE, os padrões de segurança da UE e os padrões específicos do produto. Este certificado deixa de ser válido se as unidades forem modificadas sem a nossa aprovação.</p>
<p>NL EG-conformiteitsverklaring</p> <p>De ondergetekende, Husqvarna AB, 561 82 Huskvarna, Zweden, verklaart hierbij dat de producten die hieronder staan vermeld, wanneer ze onze fabriek verlaten, in overeenstemming zijn met de geharmoniseerde Europese richtlijnen, EU-normen voor veiligheid en productspecifieke normen. Dit certificaat vervalt als de producten worden aangepast zonder onze toestemming.</p>	<p>PL Deklaracja zgodności WE</p> <p>Niżej podpisany przedstawiciel firmy Husqvarna AB, 561 82 Huskvarna, Szwecja, niniejszym oświadczam, że podane poniżej wyroby opuszczające fabrykę są zgodne ze zharmonizowanymi normami UE oraz z obowiązującymi w UE przepisami bezpieczeństwa i normami dotyczącymi danego produktu. Modyfikacja wyrobów bez naszej zgody powoduje unieważnienie niniejszego certyfikatu.</p>
<p>SV EG-försäkran om överensstämmelse</p> <p>Undertecknad firma Husqvarna AB, 561 82 Huskvarna, Sverige, intygar härmed att nedan nämnda produkter, när de lämnar vår fabrik, överensstämmer med EU:s riktlinjer, EU:s säkerhetsstandarder och produktspecifika standarder. Detta intyg skall giltigförklaras om produkten ändras utan vårt godkännande.</p>	<p>HU EK megfeleléségi nyilatkozat</p> <p>Alulírott Husqvarna AB, 561 82 Huskvarna, Svédország ezzel tanúsítja, hogy az alábbiakban leírt egységek a gyár elhagyásakor megfeleltek a harmonizált uniós előírásoknak és biztonsági és termékspecifikus szabványoknak. Ez a tanúsítvány érvényét veszti, ha az egységeket jóváhagyásunk nélkül átalakítják.</p>
<p>DA EU-overensstemmelseserklæring</p> <p>Undertegnede, Husqvarna AB, 561 82 Huskvarna, Sverige erklærer hermed, at nedenfor anførte enheder er i overensstemmelse med de harmoniserede EU-retningslinjer, EU-standarder for sikkerhed og produktspecifikke standarder, når de forlader fabrikken. Denne erklæring ugyldiggøres, hvis enhederne ændres uden vores godkendelse.</p>	<p>CS Prohlášení o shodě ES</p> <p>Niže uvedená společnost Husqvarna AB, 561 82 Huskvarna, Švédsko, tímto potvrzuje, že při opuštění naší továrny jsou jednotky uvedené níže v souladu s harmonizovanými pokyny EU, standardy EU ohledně bezpečnosti a specifickými produktovými standardy. Tento certifikát pozbývá platnosti, pokud dojde k úpravě jednotek bez našeho schválení.</p>
<p>FI EY-vaatimustenmukaisuusvakuutus</p> <p>Husqvarna AB, 561 82 Huskvarna, Ruotsi, vakuuttaa täten, että alla mainitut laitteet ovat tehtaalta lähtiesään yhdenmukaiset EU-säännösten, EU:n turvastandardien ja tuotekohtaisten standardien mukaisia. Tämä vakuutus mitätöityy, jos laitteita muutetaan ilman hyväksyntäämme.</p>	<p>SK EÚ vyhlásenie o zhode</p> <p>Dolu podpísaná spoločnosť Husqvarna AB, 561 82 Huskvarna, Švédsko týmto osvedčuje, že nižšie uvedené jednotky boli v súlade s harmonizovanými usmerneniami EÚ, normami EÚ v oblasti bezpečnosti a špecifickými normami týkajúcimi sa produktu v čase opustenia výrobného závodu. Toto osvedčenie stráca platnosť, ak boli jednotky zmenené bez nášho súhlasu.</p>

<p>EL Δήλωση Συμμόρφωσης EK H υπογεγραμμένη εταιρεία, Husqvarna AB, 561 82 Huskvarna, Σουηδία, πιστοποιεί ότι, κατά την έξοδο από το εργοστάσιο, οι μονάδες που αναφέρονται κατωτέρω συμμορφώνονται με τις ενωμοσύμιες οδηγίες ΕΕ, τα πρότυπα ασφαλείας της ΕΕ και τα συγκριμένα πρότυπα προϊόντος. Αυτό το πιστοποιητικό καθίσταται άκυρο εάν οι μονάδες έχουν τροποποιηθεί χωρίς την έγκρισή μας.</p>	<p>BG Декларация за съответствие на ЕО С настоящото долуподписаната, Husqvarna AB, 561 82 Huskvarna, Швеция, удостоверява, че при напускане на фабриката модулите, посочени по-долу, са в съответствие с хармонизираните директиви на ЕС, стандартите на ЕС за безопасност и специфичните за продукта стандарти. Този сертификат става невалиден, ако модулите са променени без нашето одобрение.</p>
<p>SL Izjava ES o skladnosti Spodaj podpisana, Husqvarna AB, 561 82 Huskvarna, Švedska, s to izjavo potrjuje, da je bila spodaj navedena enota ob izhodu iz tovarne skladna z usklajenimi smernicami EU, standardi EU za varnost in standardi, specifičnimi za izdelek. Izjava postane neveljavna v primeru neodobrene spremembe enote.</p>	<p>ET EÜ vastavusdeklaratsioon Allakirjutatu Husqvarna AB, 561 82 Huskvarna, Rootsi, kinnitab käesolevaga, et tehasest väljumisel vastavad allpool nimetatud seadmed harmoneeritud EL-i suunistele, EL-i ohutusstandarditele ja tootele eriomastele standarditele. See vastavuskinnitus kaotab kehtivuse, kui seadmed muudetakse ilma meie heakskiiduta.</p>
<p>HR Izjava o usklađenosti EZ Niže potpisana Husqvarna AB, 561 82 Huskvarna, Švedska, ovime potvrđuje kako su u nastavku navedene jedinice prilikom napuštanja tvornice bile u skladu s usklađenim smjernicama EU, EU sigurnosnim standardima i standardima specifičnima za proizvod. Ova certifikacija poništava se ako se jedinice izmjenjuju bez odobrenja.</p>	<p>LT EB atitikties deklaracija Husqvarna AB, 561 82 Huskvarna, Sweden, garantuoja, kad iš gamyklos siunčiami toliau nurodyti įrenginiai atitinka suderintus EB reikalavimus, EB saugos ir konkretaus gaminio standartus. Pakeitus gaminį be mūsų patvirtinimo, nutraukiamas šio sertifikato galiojimas.</p>
<p>RO Declarație de conformitate CE Subscrisa, Husqvarna AB, 561 82 Husqvarna, Suedia, certifică prin prezenta că, la momentul ieșirii din fabrica noastră, unitățile indicate mai jos sunt în conformitate cu directivele UE armonizate, cu standardele UE de siguranță și cu standardele specifice ale produsului. Prezentul certificat devine nul dacă unitățile sunt modificate fără aprobarea noastră.</p>	<p>LV EK atbilstības deklarācija Uzņēmums Husqvarna AB, 561 82 Huskvarna, Zviedrija, ar parakstu apliecina, ka tālāk minētās vienības, pamatot rūpniec, atbilst saskaņotajām ES vadlīnijām, ES drošības standartiem un izstrādājumam specifiskajiem standartiem. Šis sertifikāts tiek anulēts, ja šīs vienības tiek modificētas bez mūsu apstiprinājuma.</p>

<p>Produktbezeichnung: System-Akku Description of the product: System battery Désignation du produit : Batterie du système Beschrijving van het product: Systeemaccu Beskrivning av produkten: Systembatteri Beskrivelse af produktet: Systembatteri Tuotteen kuvaus: Järjestelmäakku Descrizione del prodotto: Batteria Descripción del producto: Batería del sistema Descrição do produto: Bateria do sistema Opis produktu: Akumulator systemowy</p>	<p>A termék leírása: Rendszerakkumulátor Popis výrobku: Systémová baterie Popis produktu: Systémový akumulátor Περιγραφή του προϊόντος: Μπαταρία συστήματος Opis izdelka: Sistemska baterija Opis proizvoda: Baterija Descrierea produsului: Bateria Описание на продукта: Батерия за системата Toote kirjeldus: Akusüsteem Gaminio aprašas: Sistemos akumulatorius Izstrādājuma apraksts: Sistēmas akumulators</p>
--	--

Deutschland / Germany

GARDENA Manufacturing GmbH
Central Service
Hans-Lorenser-Straße 40
D-89079 Ulm
Produktfragen:
(+49) 731 490-123
Reparaturen:
(+49) 731 490-290
service@gardena.com

Albania

COBALT Sh.p.k.
Rr. Siri Kodra
1000 Tirana

Argentina

Husqvarna Argentina S.A.
Av. del Libertador 5954 –
Piso 11 – Torre B
(C1428ARP) Buenos Aires
Phone: (+54) 11 5194 5000
info.gardena@ar.husqvarna.com

Armenia

Garden Land Ltd.
61 Tigran Mets
0005 Yerevan

Australia

Husqvarna Australia Pty. Ltd.
Locked Bag 5
Central Coast BC
NSW 2252
Phone: (+61) (0) 2 4352 7400
customer.service@
husqvarna.com.au

Austria / Österreich

Husqvarna Austria GmbH
Industriezeile 36
4010 Linz
Tel.: (+43) 732 77 01 01-485
service.gardena@
husqvarnagroup.com

Azerbaijan

Firm Progress
a. Aliyev Str. 26A
1052 Bakı

Belgium

Husqvarna België nv/sa
Gardena Division
Rue Eglise Van Ophem 111
1180 Uccle/Ukkel
Tel.: (+32) 2 720 92 12
Mail: info@gardena.be

Bosnia / Herzegovina
SILK TRADE d.o.o.
Industrijska zona Bukva bb
74260 Tešanj

Brazil

Husqvarna do Brasil Ltda
Av. Francisco Matarazzo,
1400 – 19º andar
São Paulo – SP
CEP: 05001-903
Tel: 0800-112252
marketing.br.husqvarna@
husqvarna.com.br

Bulgaria

AGROLAND България АД
бул. 8 Декември, № 13
Офис 5
1700 Студентски град
София
Tel.: (+359) 2466 6910
info@agroland.eu

Canada / USA

GARDENA Canada Ltd.
100 Summerlea Road
Brampton, Ontario L6T 4X3
Phone: (+1) 905 792 93 30
info@gardenacanada.com

Chile

Maquinarias Agroforestales
Ltda. (Maga Ltda.)
Santiago, Chile
Avda. Chesterton
8355 comuna Las Condes
Phone: (+56) 2 202 4417
Dalton@maga.cl
Zipcode: 7560330

China

Husqvarna (Shanghai)
Management Co., Ltd.
富世华 (上海) 管理有限公司
3F, Benq Square B,
No207, Song Hong Rd.,
Chang Ning District,
Shanghai, PRC. 200335
上海市长宁区淞虹路207号明
基广场B座3楼, 邮编: 200335

Colombia

Husqvarna Colombia S.A.
Calle 18 No. 68 D-31, zona
Industrial de Montevideo
Bogotá, Cundinamarca
Tel. 571 2922700 ext. 105
jairo.salazar@husqvarna.com.co

Costa Rica

Compania Exim
Euroberoamericana S.A.
Los Colegios, Moravia,
200 metros al Sur del Colegio
Saint Francis – San José
Phone: (+506) 297 68 83
exim_euro@racsa.co.cr

Croatia

SILK ADRIA d.o.o.
Josipa Lončara 3
10090 Zagreb
Phone: (+385) 1 3794 580
silk.adria@zg.t-com.hr

Cyprus

Med Marketing
17 Digeni Akrita Ave
P.O. Box 27017
1641 Nicosia

Czech Republic

Husqvarna Česko s.r.o.
Türkova 2319/5b
149 00 Praha 4 – Chodov
Bezplatná infolinka :
800 100 425
servis@cz.husqvarna.com

Denmark

GARDENA DANMARK
Lejrvej 19, st.
3500 Værløse
Tlf.: (+45) 70 26 47 70
husqvarna@husqvarna.dk
www.gardena.com / dk

Dominican Republic

BOSQUESA, S.R.L
Carretera Santiago Lacey
Km. 5 ½
Esquina Copal II.
Santiago
Dominican Republic
Phone: (+809) 736-0333
joserbosquesa@claro.net.do

Ecuador

Husqvarna Ecuador S.A.
Arupos E1-181 y 10 de
Agosto Quito, Pichincha
Tel. (+593) 22800739
francisco.jacome@
husqvarna.com.ec

Estonia

Husqvarna Eesti OÜ
Gardena Division
Valdeku 132
Tallinn
11216, Estonia
info@gardena.ee

Finland

Oy Husqvarna Ab
Gardena Division
Lautatarhankatu 8 B / PL 3
00581 HELSINKI
info@gardena.fi

France

Husqvarna France
9/11 Allée des pierres mayettes
92635 Gennevilliers Cedex
France
http : //www.gardena.com/ fr
N° AZUR: 0 810 00 78 23
(Prix d'un appel local)

Georgia

ALD Group
Bellashvili 8
1159 Tbilisi

Great Britain

Husqvarna UK Ltd
Preston Road
Aycliffe Industrial Park
Newton Aycliffe
County Durham
DL5 6UP
info.gardena@husqvarna.co.uk

Greece

Π.ΠΑΠΑΔΟΠΟΥΛΟΣ ΑΕΒΕ
Λεωφ. Αθηνών 92
Αθήνα
T.K.104 42
Ελλάδα
Τηλ. (+30) 210 5193 100
info@papadopoulos.com.gr

Hungary

Husqvarna Magyarország Kft.
Ezred u. 1-3
1044 Budapest
Telefon: (+36) 1 251-4161
vevozolgalat.husqvarna@husqvarna.hu

Iceland

Ó. Johnson & Kaaber
Tunguhalsi 1
1110 Reykjavik
ooj@ojk.is

Ireland

Husqvarna UK Ltd
Preston Road
Aycliffe Industrial Park
Newton Aycliffe
County Durham
DL5 6UP
info.gardena@husqvarna.co.uk

Italy

Husqvarna Italia S.p.A.
Via Santa Vecchia 15
23868 VALMADRERA (LC)
Phone: (+39) 0341.203.111
assistenza.italia@it.husqvarna.com

Japan

KAJICHI Co. Ltd.
Sumitomo Realty &
Development Kojimachi
BLDG. 8F
5-1 Nibannycyo
Chiyoda-ku
Tokyo 102-0084
Phone: (+81) 33 264 4721
m_ishihara@kaku-ichi.co.jp

Kazakhstan

LAMED Ltd.
155/1, Tazhibayevoi Str.
050060 Almaty
IP Schmidt
Abayavenue 3B
110 005 Kostanay

Korea

Kyung Jin Trading CO.,LTD.
107-4, SunDuk Bld.,
YangJae-dong,
Seocho-gu,
Seoul, (zipcode: 137-891)
Phone: (+82) (0)2 574-6300

Kyrgyzstan

Alye Maki
av. Molodaya Guardir J 3
720014
Bishkek

Latvia

Husqvarna Latvija SIA
Gardena Division
Ulbrokas 19A
LV-1021 Riga
info@gardena.lv

Lithuania

UAB Husqvarna Lietuva
Gardena Division
Ateities pl. 77C
LT-52104 Kaunas
info@gardena.lt

Luxembourg

Magasins Jules Neuberg
39, rue Jacques Stas
Luxembourg-Gasperich 2549
Case Postale No. 12
Luxembourg 2010
Phone: (+352) 40 14 01
api@neuberg.lu

Mexico

AFOSA
Av. Lopez Mateos Sur # 5019
Col. La Calma 45070
Zapopan, Jalisco, Mexico
Phone: (+52) 33 3818-3434
icornejo@afosa.com.mx

Moldova

Convel S.R.L.
290A Muncestri Str.
2002 Chisinau

Netherlands

Husqvarna Nederland B.V.
GARDENA Division
Postbus 50131
1305 AC ALMERE
Phone: (+31) 36 521 00 10
info@gardena.nl

Neth. Antilles

Jonka Enterprises N.V.
Sta. Rosa Weg 196
P.O. Box 8200
Curaçao
Phone: (+599) 9 767 66 55
pgm@jonka.com

New Zealand

Husqvarna New Zealand Ltd.
PO Box 76-437
Manukau City 2241
Phone: (+64) (0) 9 9202410
support.nz@husqvarna.co.nz

Norway

Husqvarna Norge AS
Gardena Division
Treskenveien 36
1708 Sarpsborg
Tel: 69 10 47 00
www.gardena.no

Peru

Husqvarna Perú S.A.
Jr. Ramón Cárcamo 710
Lima 1
Tel: (+51) 1 3320400 ext. 416
juan.remuzgo@husqvarna.com

Poland

Husqvarna
Poland Spółka z o.o.
ul. Wysockiego 15 b
03-371 Warszawa
Phone: (+48) 22 330 96 00
gardena@husqvarna.com.pl

Portugal

Husqvarna Portugal, SA
Lagoa - Albarraque
2635 - 595 Rio de Mouro
Tel.: (+351) 21 922 85 30
Fax : (+351) 21 922 85 36
info@gardena.pt

Romania

Madex International Srl
Soseaua Odaii 117 - 123,
RO 013603 Bucuresti, S1
Phone: (+40) 21 352.76.03
madex@imes.ro

Russia / Россия

ООО „Хускварна“
141400, Московская обл.,
г. Химки,
улица Ленинградская,
владение 39, стр.6
Бизнес Центр
„Химки Бизнес Парк“,
помещение ОВ02_04
http://www.gardena.ru

Serbia

Domel d.o.o.
Autoput za Novi Sad bb
11273 Belgrade
Phone: (+381) 1 18 48 88 12
miroslav.zejgna@domel.rs

Singapore

Hy-Ray PRIVATE LIMITED
40 Jalan Pemimpin
#02-08 Tat Ann Building
Singapore 577185
Phone: (+65) 6253 2277
shiyang@hyray.com.sg

Slovak Republic

Husqvarna Česko s.r.o.
Türkova 2319/5b
149 00 Praha 4 – Chodov
Bezplatná infolinka:
800 154 044
servis@sk.husqvarna.com

Slovenia

Husqvarna Austria GmbH
Industriezeile 36
4010 Linz
Tel.: (+43) 732 77 01 01-485
service.gardena@
husqvarnagroup.com

South Africa

Husqvarna
South Africa (Pty) Ltd
Postnet Suite 250
Private Bag X6,
Cascades, 3202
South Africa
Phone: (+27) 33 846 9700
info@gardena.co.za

Spain

Husqvarna España S.A.
Calle de Rivas nº 10
28052 Madrid
Phone: (+34) 91 708 05 00
atencioncliente@gardena.es

Suriname

Agrofix n.v.
Verlengde Hogestraat #22
Phone: (+597) 472426
agrofix@sr.net
Pobox : 2006
Paramaribo
Suriname – South America

Sweden

Husqvarna AB
Gardena Division
S-561 82 Huskvarna
info@gardena.se

Switzerland / Schweiz

Husqvarna Schweiz AG
Consumer Products
Industriestrasse 10
5506 Mägenwil
Phone: (+41) (0) 62 887 37 90
info@gardena.ch

Turkey

Dost Bahçe Diş Ticaret
Müessesilik A.Ş
Yunus Mah. Adil Sok. No: 3
İc Kapı No: 1 Kartal
34873 İstanbul
Phone: (+90) 216 38 93 939
info@dostbahce.com.tr

Ukraine / Україна

ТОВ «Хусварна Україна»
вул. Васильківська, 34,
офіс 204-р
03022, Київ
Тел. (+38) 044 498 39 02
info@gardena.ua

Uruguay

FELI SA
Entre Rios 1083 CP 11800
Montevideo – Uruguay
Tel : (+598) 22 03 18 44
info@felisa.com.uy

Venezuela

Corporación Casa y Jardín C.A.
Av. Caroni, Edif. Trezmen, PB.
Colinas de Bello Monte.
1050 Caracas.
Tlf : (+58) 212 992 33 22
info@casayjardin.net.ve

9842-20.960.03/1017
© GARDENA Manufacturing GmbH
D-89070 Ulm
http://www.gardena.com